

CUSTOMER REFERENCE DRAWING

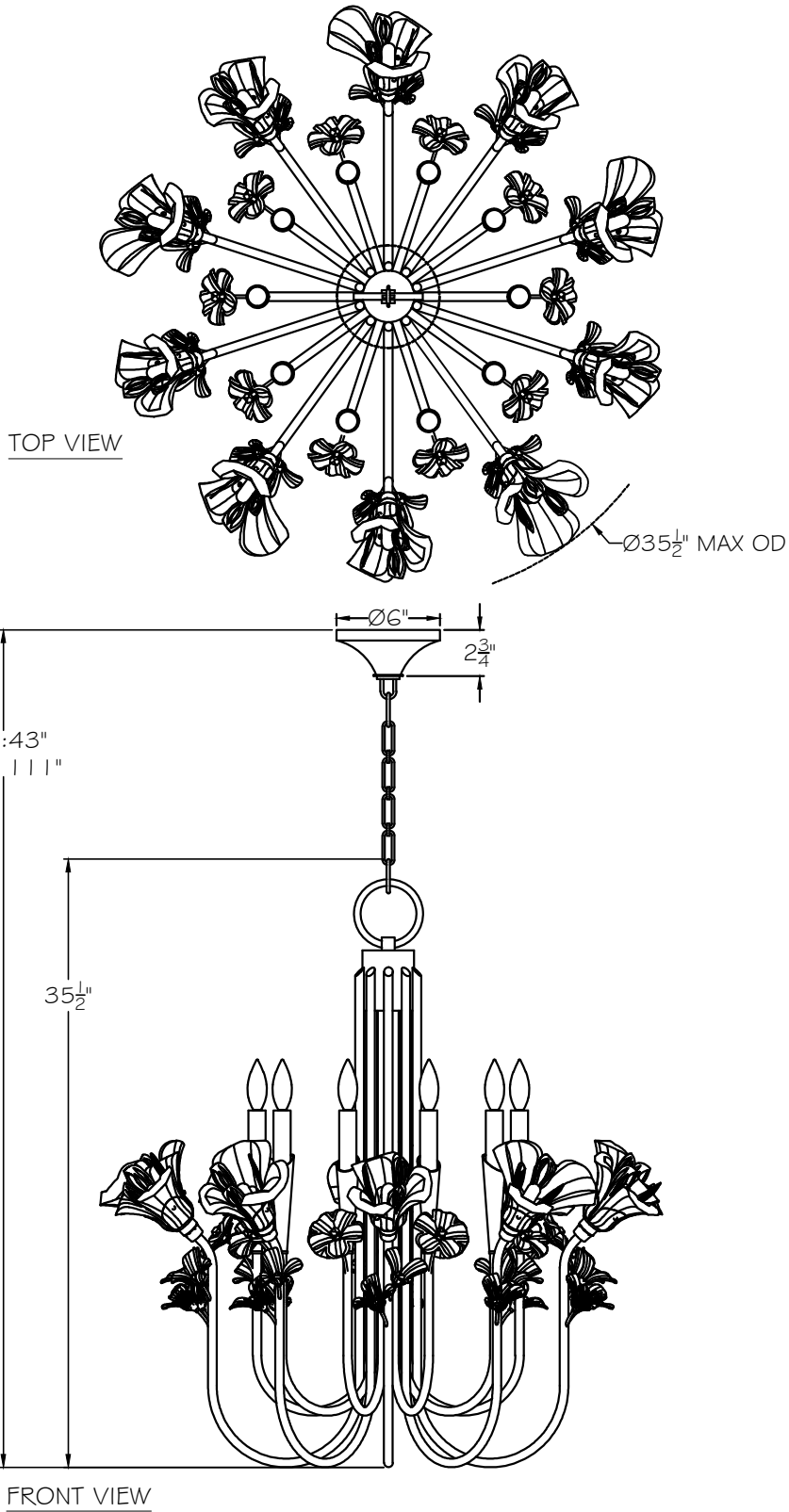

STYLE CONFIGURATIONS:

-1ST SILVER	-2ST GOLD	-3ST WHITE GESSO		
-------------	-----------	------------------	--	--



This drawing, specifications and the product depicted are the exclusive property of Fine Art Handcrafted Lighting®. In compliance with US copyright and patent requirements, notice is hereby given that this document and the product depicted shall not be copied, altered or used in any manner without the expressed written consent of Fine Art Handcrafted Lighting®.

www.finearthl.com

Tel:(305) 821-3850
FINE ART LAMPS®

Fax:(305) 513-5736

STYLE NUMBER:

915140

DATE:

8/26/20

CRYSTAL REFERENCE DRAWING

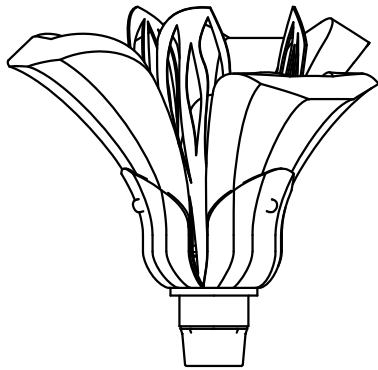

LARGE LIGHT FLOWER ASSEMBLY (X5 TOTAL)

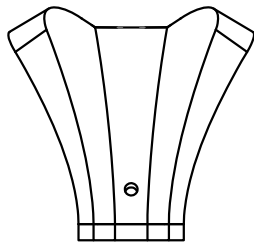

(X1 PER ASSEMBLY)
LARGE CRYSTAL PETAL
#00301204

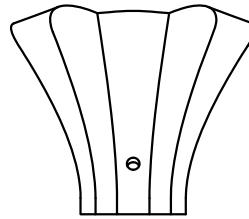

(X1 PER ASSEMBLY)
MEDIUM CRYSTAL PETAL
#00301205

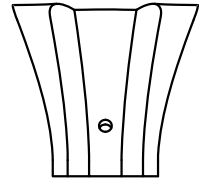

(X1 PER ASSEMBLY)
SMALL CRYSTAL PETAL
#00301206

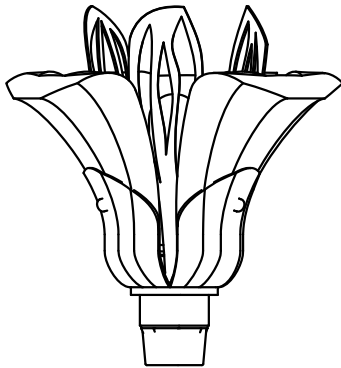

SMALL LIGHT FLOWER ASSEMBLY (X5 TOTAL)

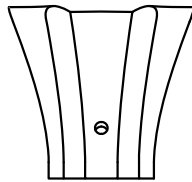

(X3 PER ASSEMBLY)
SMALL CRYSTAL PETAL
#00301206

FLAT FLOWER ASSEMBLY (X10 TOTAL)



(X1 PER ASSEMBLY)
CRYSTAL PETAL CLUSTER
#00301203

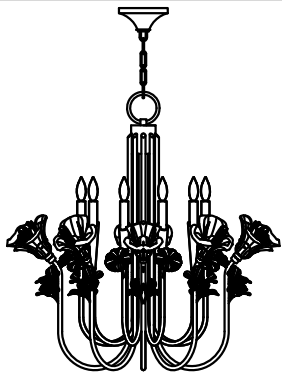

SOCKET THREADED
COLLAR #00401212

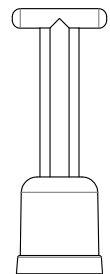

ASSEMBLY TOOL
#00201493
(NOT INCLUDED)

STYLE(S) #: 915140



This drawing, specifications and the product depicted are the exclusive property of Fine Art Handcrafted Lighting®. In compliance with US copyright and patent requirements, notice is hereby given that this document and the product depicted shall not be copied, altered or used in any manner without the expressed written consent of Fine Art Handcrafted Lighting®.

www.finearthl.com

Tel:(305) 821-3850
FINE ART LAMPS®

Fax:(305) 513-5736

INSTRUCTION #:

00791437

SHEET

1 / 1